

**SERIAL NO: FC \*\*\*\* - UK**

# **V-fit**



---

**AL16/1E Magnetic Elliptical Trainer**

***Assembly & User Manual***

**Please ensure that you read this manual carefully before attempting to assemble or use your new product and retain for future use**



# Contents

---

<i>Section</i>	<i>Page</i>
<b><i>General Information</i></b> . . . . .	<b>4</b>
<b><i>Before You Start</i></b> . . . . .	<b>5</b>
<b><i>Safety</i></b> . . . . .	<b>6</b>
<b><i>Exercise Information</i></b> . . . . .	<b>7</b>
<b><i>Assembly &amp; Adjustments</i></b> . .	<b>14</b>
<b><i>Assembly</i></b> . . . . .	<b>16</b>



*Protect the environment by not disposing of this product with household waste.*

---



# General Information

---

## Quality

This exercise product has been designed and manufactured to comply with the latest (BS EN 957) British and European Safety Standards.

## Questions

Should you encounter any difficulty with the assembly, operation or use of your exercise product or if you think that you may have parts missing, please **DO NOT** return it to your retailer but contact us first for help and advice, asking for **CUSTOMER SUPPORT**, by any of the following means.

Tel:- 01535 637711 or  
Fax:- 01535 637722 or  
Email:- [support@benysports.co.uk](mailto:support@benysports.co.uk)  
Website: [www.benysports.co.uk](http://www.benysports.co.uk)

**CUSTOMER SUPPORT** is open from 9.00am to 5.00pm from Monday to Friday

Beny Sports Co. UK Ltd.  
Unit 8, Riparian Way,  
The Crossings, Cross Hills,  
West Yorkshire.  
BD20 7BW

## Queries

If you do have any queries, please ensure that you have the following information ready for our Customer Support Staff:

YOUR NAME  
YOUR ADDRESS  
YOUR PHONE NUMBER  
PRODUCT MAKE OR BRAND  
PRODUCT MODEL  
PRODUCT SERIAL NUMBER  
DATE OF PURCHASE  
NAME OF RETAILER  
PART NUMBERS REQUIRED

## Guarantee

This product is guaranteed for **DOMESTIC USE ONLY** for a period of **1 YEAR** from the original certified date of purchase. During this period we have the right to: -

- Provide parts for the purchaser to effect repair.
- Repair the product, returned to our warehouse (at the purchaser's cost).
- Replace the product if it is deemed (by us) to be economical to do so.

This guarantee does not cover wear and tear on upholstery or consumables.

This guarantee does not cover abuse, defects caused by storage or use outside those intended.

If you need to advise us of a defect with your product and in order for us to service any requirement for replacement parts or repairs, we will ask for proof of purchase. Failure to do so will result in any claim for replacement parts or repairs being refused.

This guarantee, (both given and implied) applies to the original purchaser only, is not transferable and will be invalidated if used outside of the above criteria.

This guarantee is valid only in the United Kingdom and Eire.

This does not affect your statutory rights as a consumer.

## Customer Support

Tel:- 01535 637711 or  
Fax:- 01535 637722 or  
Email:- [support@benysports.co.uk](mailto:support@benysports.co.uk)  
Website: [www.benysports.co.uk](http://www.benysports.co.uk)

**CUSTOMER SUPPORT** is open from 9.00am to 5.00pm from Monday to Friday

Beny Sports Co. UK Ltd.  
Unit 8, Riparian Way,  
The Crossings, Cross Hills,  
West Yorkshire  
BD20 7BW

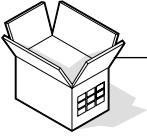

# Before you Start

---

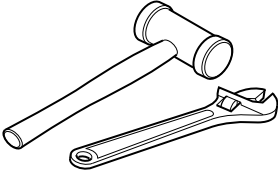

## Tools

*If required, most of our products are supplied with basic tools, which will enable you to successfully assemble your product. However, you may find it beneficial to have a soft-headed hammer and perhaps an adjustable spanner handy as this may help.*

## Prepare the Work Area

*It is important that you assemble your product in a clean, clear, uncluttered area. This will enable you to move around the product while you are fitting components and will reduce the possibility of injury during assembly.*

## Work with a Friend

*You may find it quicker, safer and easier to assemble this product with the help of a friend as some of the components may be large, heavy or awkward to handle alone.*

## Open the Carton.

*Carefully open the carton that contains your product, taking note of the warnings printed on the carton to ensure that the risk of injury is reduced. Be aware of sharp staples that may be used to fasten the flaps as these may cause injury. Be sure to open the carton the right way up, as this will be the easiest and safest way to remove all the components.*

## Unpack the Components

*Carefully unpack each component, checking against the parts list that you have all the necessary parts to complete the assembly of your product.*

*Please note that some of the parts may be pre-fitted to major components, so please check carefully before contacting our CUSTOMER SUPPORT team.*

*In any event, please do not return the product to your retailer before contacting us first.*



# Safety

*Before you undertake any programme of exercise that will increase cardiovascular activity please be sure to consult with your doctor. Frequent strenuous exercise should be approved by your doctor and proper use of your product is essential. Please read this manual carefully before commencing assembly of your product or starting to exercise.*

- \* Please keep all children away from exercise products when in use. Do not allow children to climb or play on them when they are not in use. If children are allowed to use the equipment, their mental and physical development and above all their temperament should be taken into account. They should be controlled and instructed to the correct use of the equipment. The equipment is under no circumstances suitable as a children's toy.*
- \* For your own safety, always ensure that there is at least 2 metres of free space in all directions around your product while you are exercising.*
- \* Regularly check to see that all nuts, bolts and fittings are securely tightened. Periodically checking all moving parts for obvious signs of wear or damage.*
- \* Clean only with a damp cloth, do not use solvent cleaners. If you are in any doubt, do not use your product, but contact CUSTOMER SUPPORT by any of the means listed on the opposite page.*
- \* Before use, always ensure that your product is positioned on a solid, flat surface. If necessary, use a rubber mat underneath to reduce the possibility of damaging flooring or slipping in use.*
- \* Always wear appropriate clothing and footwear such as training shoes when exercising. Do not wear loose clothing that could become caught or trapped during exercise.*
- \* Parents and others in charge of children should be aware of their responsibility because the natural play instinct and the fondness of experimenting of children can lead to situations and behavior for which the training equipment is not intended.*



## Warning

*If any part of your product becomes damaged, broken or badly worn do not use the equipment until the defective parts have been replaced*

## Storage and Use

*Your product is intended for use in clean dry conditions. You should avoid storage in excessively cold or damp places as this may lead to corrosion and other related problems that are outside our control.*

## Weight Limit

*Your product is suitable for users weighing:  
242LBS / 17.2 Stones / 110KG or less.*

## Conformity

*This product conforms to:  
BS EN ISO 20957-1 and BS EN 957-9 Class (H)-HOME USE-Class (C).  
It is NOT suitable for therapeutic purposes.*



# Exercising Information

---

## **Beginning**

*How you begin to exercise will vary from person to person. If you have not exercised for a long period of time, have been inactive for a while, or are severely overweight you **MUST** start slowly, increasing your exercise time gradually, by perhaps only a few minutes for each session per week.*

*Combine a carefully structured nutritious diet with a simple but effective exercise routine and this can help make you feel better, look better and will almost certainly enable you to enjoy life more.*

## **Aerobic Fitness**

*Aerobic exercise is simply defined as any sustained activity that increases the supply of oxygen to your muscles via the blood pumped by your heart. With regular exercise, your cardiovascular system will become stronger and more efficient. Your recovery rate i.e. the time taken for your heart to reach its normal resting level, will also decrease.*

*Initially you may only be able to exercise for a few minutes each day. Do not hesitate to breathe through your mouth should you need more oxygen. Use the "talk test". If you cannot carry on a conversation while exercising, you are working too hard! However, aerobic fitness will be gradually built up with regular exercise, over the next six to eight weeks.*

*Do not be discouraged if it takes longer than this to begin to feel less lethargic, everyone is different and some will achieve their targets quicker than others. Work at your own, comfortable pace and the results will come. The better your aerobic fitness the harder you will have to work to stay in your target zone.*



# Exercising Information

---

## Warm Up

*A successful exercise programme consists of three parts, Warm Up, Aerobic Exercise and Cool Down. Never start a training session without warming up. Never finish one without cooling down correctly. Perform between five and ten minutes of stretching before starting your workout to prevent muscle strains, pulls and cramps.*

## Aerobic Exercise Session

*Those new to exercise should exercise no more than every other day to start with.*

*As your fitness level increases, increase this to 2 in every 3 days.*

*When you are comfortable with your routine, exercise for 6 days per week. Always take at least one day off per week.*

## Exercising in your Target Zone

*To ensure that your heart is working in its exercise target zone, you need to be able to take your pulse. If you do not have a pulse monitor (either from the product you are using or a proprietary independent unit) you will need to locate the pulse in your carotid artery. This is situated in the side of the neck and can be felt by using the index and middle fingers. Simply count the number of beats you feel in 10 seconds and then multiply by six to get your pulse rate. This should be taken before you start to exercise for easy reference.*

*People who have a greater aerobic fitness, have a lower resting pulse level and will also be able to exercise with a higher pulse level.*

## Target Zone

*To determine your target zone, see the chart opposite. If you are new to exercise and by definition unfit, refer to the left column. If you exercise regularly and have good aerobic fitness, refer to the right column.*





# Exercising Information

## Target Zone (con't)

<b>USERS AGE</b>	<b>UNCONDITIONED TARGET ZONE - A</b>	<b>CONDITIONED TARGET ZONE - B</b>
(Years)	(Beats per Minute)	(Beats per Minute)
20-24	145 - 165	155 - 175
25-29	140 - 160	150 - 170
30-34	135 - 155	145 - 165
35-39	130 - 150	140 - 160
40-44	125 - 145	135 - 155
45-49	120 - 140	130 - 150
50-54	115 - 135	125 - 145
55-59	110 - 130	120 - 140
60 and over	105 - 125	115 - 135

## Cool Down

To decrease fatigue and muscle soreness, you should also cool down by walking at a slow relaxed pace for a minute or so, to allow your heart rate to return to normal.

## Warm Up and Cool Down Exercises

Hold each stretch for a minimum of ten seconds and then relax. Repeat each stretch two or three times. Do this before your Aerobic Exercise session and also after you have finished.

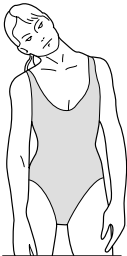

### Head Roll

Rotate your head to the right for one count, feeling a slight pull on the left side of your neck. Next, rotate your head back for one count, stretching your chin. Then rotate your head to the left for one count, feeling a slight pull on the right side of your neck. Lastly, drop your head to your chest for one count. Repeat 2 to 3 times.

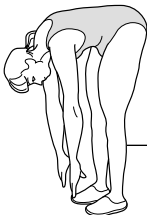

### Toe Touch

Slowly bend forward from your waist, letting your back and shoulders relax as you lower your trunk. Gently stretch down as far as is comfortable and hold for 10 seconds.

# Exercising Information

---



## Shoulder Lift

Rotate and lift your right shoulder up towards your ear for one count. Relax then repeat for the left shoulder. Repeat 3 - 4 times.

## Calf / Achilles Stretch

Turn towards the wall and place both hands on it. Support yourself with one leg while the other is placed behind you with the sole flat on the floor. Bend the front leg and lean towards the wall, keeping the rear leg straight so that the calf and Achilles tendon are stretched hold for 5 seconds. Repeat with the other leg. Repeat 2 - 3 times.

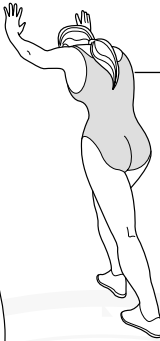

## Side Stretch

Open both arms to the side and gently lift them above your head. Reach your right arm as high as you can for one count, gently stretching the muscles of the stomach and lower back. Repeat the action with your left arm. Repeat 3 - 4 times.

## Inner Thigh Stretch

Sit on the floor and pull your legs toward your groin, the soles of your feet together. Hold your back straight and lean forward over your feet. Tighten the thigh muscles and hold for 5 seconds. Release and repeat 3 - 4 times.



## Hamstring Stretch

Sit on the floor with your right leg extended and place your left foot flat against the right inner thigh. Stretch forward toward the right foot and hold for 10 seconds. Relax and then repeat with the left leg extended. Repeat 2 - 3 times.

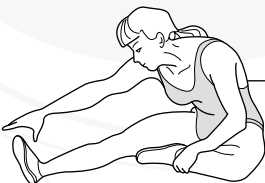



# Exercising Information

---

## **Basic Aerobic Training Programme**

*For your basic Aerobic Exercise routine we suggest that you try the following. Remember, breathe correctly, exercise at your own pace and do not over-train as injury may result.*

### **Week 1 & 2**

*Warm Up 5 - 10 Minutes  
Cool Down 5 Minutes*

*Exercise 4 minutes at 'A'  
Rest 1 minute  
Exercise 2 minutes at 'A'  
Exercise slowly 1 minute*

---

### **Week 3 & 4**

*Warm Up 5 - 10 Minutes  
Cool Down 5 Minutes*

*Exercise 5 minutes at 'A'  
Rest 1 minute  
Exercise 3 minutes at 'A'  
Exercise slowly 2 minutes*

---

### **Week 5 & 6**

*Warm Up 5 - 10 Minutes  
Cool Down 5 Minutes*

*Exercise 6 minutes at 'A'  
Rest 1 minute  
Exercise 4 minutes at 'A'  
Exercise slowly 3 minutes*

---

### **Week 7 & 8**

*Warm Up 5 - 10 Minutes  
Cool Down 5 Minutes*

*Exercise 5 minutes at 'A'  
Exercise 3 minutes at 'B'  
Exercise 2 minutes at 'A'  
Exercise slowly 1 minute  
Exercise 4 minutes at 'A'  
Exercise slowly 3 minutes*

---

### **Week 9 & beyond**

*Warm Up 5 - 10 Minutes  
Cool Down 5 Minutes*

*Exercise 5 minutes at 'A'  
Exercise 3 minutes at 'B'  
Exercise 2 minutes at 'A'  
Exercise slowly 1 minute  
Repeat entire cycle 2 or 3 times*

---

*This is only a suggested programme and may not suit every individual's needs.*

# EXERCISE MONITOR USER INSTRUCTIONS

Your Exercise Monitor has been specially designed to help you plan and view your exercise performance.

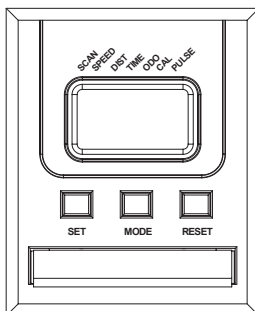

## MONITOR FUNCTION SPECIFICATIONS

<b>SCAN</b> (CHANGING FROM FUNCTION TO FUNCTION)	SHOWS EACH FUNCTION EVERY 4 SECONDS
<b>TIME</b> (MINUTES AND SECONDS - COUNT UP / DOWN)	0.00 - 99.59 Minutes and Seconds
<b>SPEED</b> (REPRESENTATIVE SPEED - KM/H)	0.00 - 999.9 Kilometres per Hour
<b>DISTANCE</b> (EXERCISE DISTANCE KM - COUNT UP / DOWN)	Kilometres
<b>ODOMETER [Total Distance]</b> (ACCUMULATED DISTANCE KM - COUNT UP)	0 - 99.99 Kilometres
<b>CALORIE BURN</b> (COMPUTED THEORETICAL CALORIE BURN*)	0.00 - 999.9 Kcal THEORETICAL *
<b>PULSE</b> (ACTUAL EXERCISE PULSE RATE**)	40 - 200 BEATS per MINUTE**

## MONITOR OPERATING SPECIFICATIONS

<b>POWER SOURCE</b>	2 x AAA (1.5v) POWER CELLS
<b>STORAGE TEMPERATURE</b>	-10°C - +60°C
<b>NORMAL OPERATING TEMPERATURE</b>	0°C - +40°C

## USING YOUR EXERCISE MONITOR

To provide ease of use, there are three touch sensitive / induction reactive buttons on your Exercise Monitor: - **SET, MODE & RESET**  
**Press** the **MODE** button to manually move through each of the Exercise Monitor's functions in turn. These are - **TIME, SPEED, DISTANCE, CALORIES, PULSE & ODOMETER** If you press the **MODE** button until you reach the **SCAN** mode (after **PULSE** mode) then release it, the **SCAN** function will become operative & the display will change approx. **EVERY 4 SECONDS** to show each function in turn.

**Pressing** the **RESET** button when you are in any mode will enable you to set to zero any previous figures remaining in each individual function except **ODOMETER (TOTAL DISTANCE)** which will continue to accumulate a distance reading unless the Batteries are removed.

**START** to exercise or press the **MODE** button and the Exercise Monitor will begin to register the various functions.

You are able to set Exercise Targets in the following functions: - **TIME, DISTANCE & CALORIE BURN**. To set targets for these functions, press the **SET** button when the function is active on the LCD screen and this will enable you to programme **TIME, DISTANCE** and **CALORIE BURN** to count down from your set targets. When the target has been achieved, an alarm will sound for 15 seconds to indicate completion.

Press the **MODE** button until you reach the **PULSE** function. This can be done either while exercising or at rest. **MOISTEN** your **HANDS** slightly before using the Pulse Function to ensure good contact is made on the Sensor Pads. Failure to do this may result in a bad connection and erratic Pulse readings. A representative reading, which should not be used for medical or therapeutic reasons, will show after approximately 5 seconds. The readings will stabilise after approximately 10 seconds.

**NOTE:** - Please refer to the guide in your Assembly and Training Manual for information and guidance on Exercise Pulse Limits.



# EXERCISE MONITOR USER INSTRUCTIONS

## BATTERY INSTALLATION

To fit the necessary **BATTERIES - (NOT SUPPLIED)** to your Exercise Monitor, remove the **BATTERY COVER** at the **REAR** of the monitor. Carefully fit the batteries by fitting between the exposed contacts in the battery compartment. Ensure that batteries are fitted with the '+' / '-' ends matching the outline on the sticker or in the battery compartment. Failure to fit batteries correctly may result in damage to your Exercise Monitor that is not covered by our guarantee.

**PLEASE DISPOSE OF OLD BATTERIES CAREFULLY AND CONSIDERATELY.**

### **CUSTOMER NOTICE** **EXERCISE MONITOR CABLE CONNECTION**

*In most cases where there is an apparent failure of your Exercise Monitor to work, it is due to incorrect fitment of the Exercise Monitor cable connections. So, please ensure that there is NO GAP between the connectors on the Exercise Monitor cables when finally assembled.*

*For **Jack Plug** fittings, push together the Male & Female ends to make initial contact. Push again to make final connection. When fitted correctly, the Jack Plug faces will touch each other.*

*For **2-Pin** fittings, ensure that you carefully line up the contacts in both connectors and then push firmly together ensuring that the clips lock together.*

*Before contacting our Customer Support Team (see contact details below), please re-check all cable connections, disconnecting and re-making where necessary.*

*Should you encounter any difficulty with the operation of your Exercise Monitor that is not solved by re-connection, please return it to us at the address below for inspection.*

**WE REGRET THAT ARE UNABLE TO REPLACE ANY DAMAGED OR FAULTY UNITS BEFORE INSPECTION BY US.**

*We reserve the right to repair or replace the Exercise Monitor at our discretion.*

**Beny Sports Co. UK Ltd.**  
**Unit 8, Riparian Way, The Crossings, Cross Hills, West Yorkshire. BD20 7BW**

**Tel:** - 01535 637711

**Fax:** - 01535 637722

**e-mail:** - [support@benysports.co.uk](mailto:support@benysports.co.uk)

CUSTOMER SUPPORT is open from 9.00am to 5.00pm from Monday to Friday

# Assembly & Adjustments



## Note

Incorrect or excessive training may damage your health. Please read the exercise information first.



## Note

The foot print for this product is 1400mm x 700mm.



## Note

In accordance with BS EN 957, the braking (resistance) system on this trainer is speed independent.



## Note

There may be a small amount of built in resistance present at first due to the general tight fit of the new bearings, bushes and the drive belt.

## OPERATING ADJUSTMENTS and GENERAL USER INFORMATION

### LEVELLING THE CROSS TRAINER

For security and stability, your Manual Magnetic Elliptical Trainer has a factory welded frame and once fully assembled correctly, should not need further alignment. However, in the interest of safety, please always ensure that your Cross Trainer is positioned on a solid, flat surface. If necessary, use a rubber mat underneath to reduce the possibility of damaging flooring or slipping in use. If you need to make a fine adjustment, simply twist the end of either Rear Frame Stabiliser Adjustable Hex End Cap (29) to compensate for uneven floors.

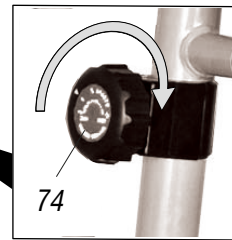
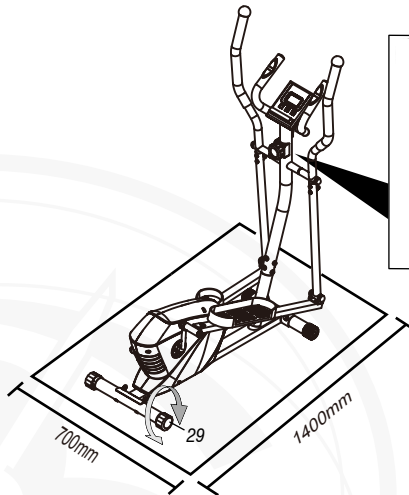

### RESISTANCE ADJUSTMENT

To ensure smooth efficient cycling action, the magnetic braking system on your Manual Magnetic Elliptical Trainer has been correctly adjusted by our factory during production. To adjust the pedalling resistance during use, starting by turning the Tension Control Knob (74) to the position "1" from the beginning of your workout. Gradually increase the pedalling resistance by turning the Tension Control Knob as required.

When you have finished your routine, turn the Tension Control Knob to the position "8" again to ensure that the Tension Control Cable is not under tension when your Manual Magnetic Elliptical Trainer not in use.



# Assembly & Adjustments

## LUBRICATION and MAINTENANCE

The moving parts in your Manual Magnetic Elliptical Trainer are all pre-lubricated at assembly and should not require further attention. We recommend however that the trainer is used inside and stored in a dry condition. To clean the metal and plastic components, a general household cleaner can be used, but please be sure to dry the trainer and any attachments before use.

## HOW TO MOUNT and DISMOUNT

Hold the handlebar and stand on the foot platform. Start your training. When you finish your workout, hold the handlebar and slow down your speed. Once stopped, step off and onto the floor carefully.

## DRIVE BELT and FLYWHEEL ALIGNMENT

It may be necessary at some stage to adjust the Drive Belt on your Manual Magnetic Elliptical Trainer. This can be achieved by removing the 8 pre-fitted Machine Screws in the Chain Guards. Loosen the Flywheel Spindle Nuts on both sides and adjust the two 10mm Alignment Bolt Nuts. Please take care to adjust each side equally to ensure that the Flywheel is kept in alignment and that there is approximately 10mm of FREEPLAY on the Drive Belt when correctly adjusted.

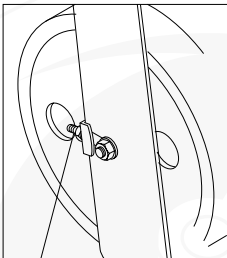

Alignment Bolts

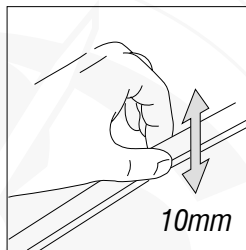

10mm

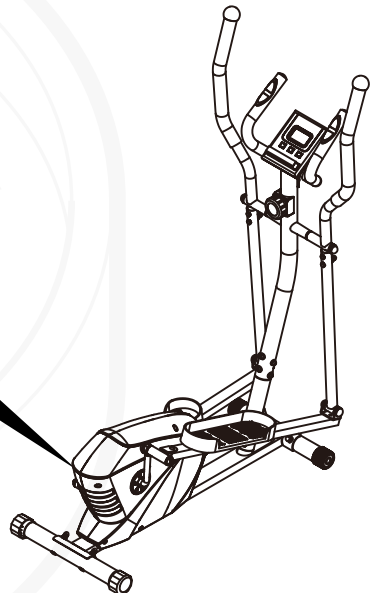

# Assembly

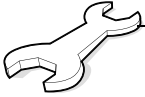

## ACCESSORY FITMENT LIST

**These are all the accessories you will need to complete the assembly of your product.**

The following accessories are supplied in a pack and should be checked before attempting assembly.

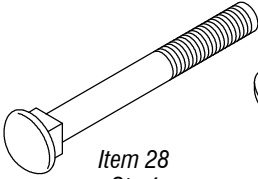

Item 28  
Qty 4



Item 27  
Qty 17



Item 26  
Qty 13

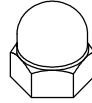

Item 25  
Qty 8



Item 49  
Qty 2

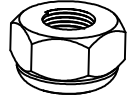

Item 48  
Qty 2

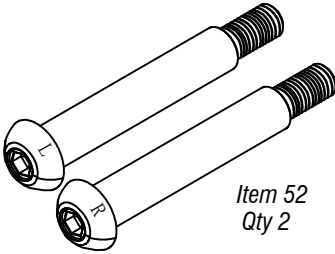

Item 52  
Qty 2



Item 51  
Qty 2



Item 47  
Qty 2

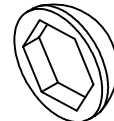

Item 60  
Qty 2

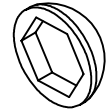

Item 63  
Qty 4

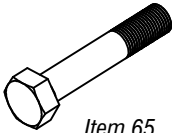

Item 65  
Qty 4

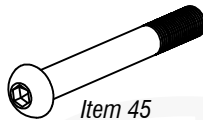

Item 45  
Qty 2

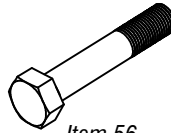

Item 56  
Qty 4

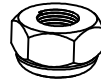

Item 57  
Qty 4

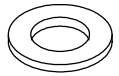

Item 58  
Qty 4

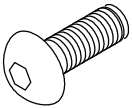

Item 46  
Qty 3

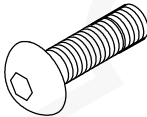

Item 77  
Qty 2



Item 37  
Qty 2



Item 85  
Qty 1

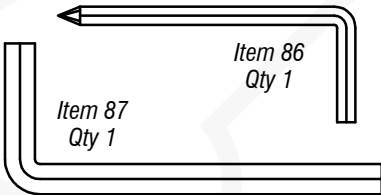

Item 87  
Qty 1

Item 86  
Qty 1

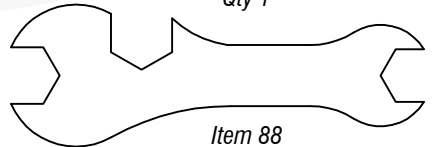

Item 88  
Qty 1



# Assembly



Carefully unpack each component, checking against the parts list that you have all the necessary parts to complete the assembly of your product.

## Beny Sports Co. UK Ltd

Unit 8, Riparian Way,  
The Crossings, Cross Hills,  
West Yorkshire.  
BD20 7BW

Please note that some of the parts may be pre-fitted to major components, so please check carefully before contacting our CUSTOMER SUPPORT team.

In any event, please do not return the product to your retailer before contacting us first.

Tel:- 01535 637711 or

Fax:- 01535 637722 or

E-mail:- [support@benysports.co.uk](mailto:support@benysports.co.uk)

CUSTOMER SUPPORT is open from 9.00am to 5.00pm from Monday to Friday



## Note

Do NOT FULLY TIGHTEN any Bolts, Nuts or Fittings at this stage unless specifically instructed to do so.

- 1 Assemble the Front and Rear Stabilisers (32 & 30) to the Main Frame (33) using 4 x M8 x 65mm Carriage Bolts (28), 4 x M8 Curved Washers (27), 4 x M8 Spring Washers (26) and 4 x M8 Dome Nuts (25) for each Stabiliser. Tighten all Bolts and Nuts securely.

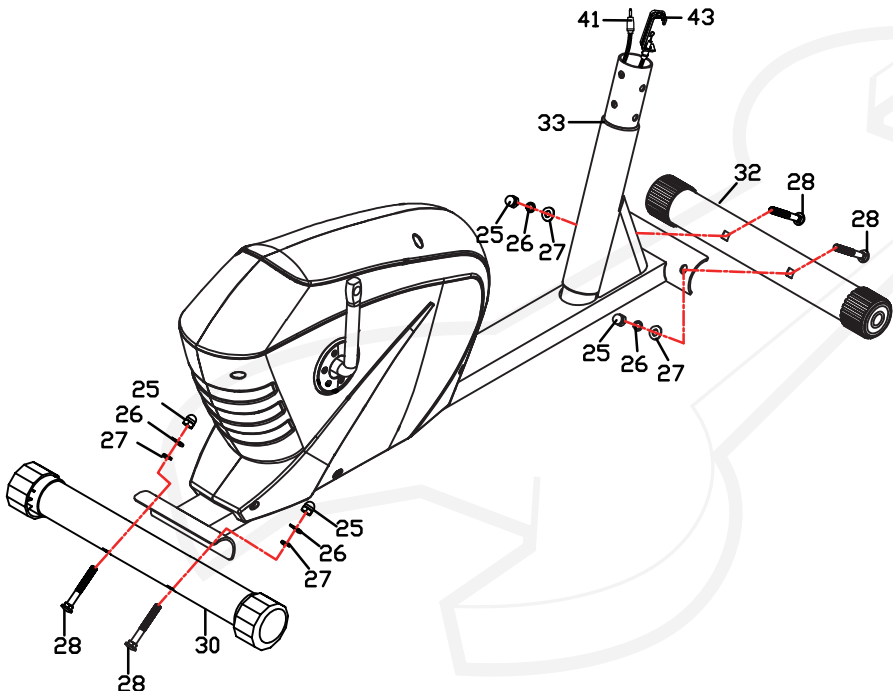

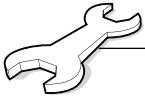

# Assembly

## 2

A-1. Hold the Tension Cable (44) below the metal bracket. Guide the lower part of the INNER Cable of the Tension Control Knob (74) into the formed metal loop on the INNER Cable of the Tension Cable.

A-2. Still holding the Tension Cable (44), pull the Tension Control Knob INNER Cable (74) away from the Metal Bracket (you will notice some resistance at this stage) and guide the INNER Cable through the open slot in the Metal Bracket.

A-3/A-4. Slowly release the tension on the UPPER Cable and guide it carefully into the hole in the top of the Metal Bracket.

Complete the fitting as shown and if necessary, close the open section of the metal bracket slightly with a pair of pliers as this will help to retain the cables. Connect the lower part of the Exercise Monitor Link Wire (41) to the Exercise Monitor Sensor Wire (42), ensuring a tight connection. Carefully lower the Handlebar Upright (73) onto the Main Frame (33), then loosely fit the Upper holes by 3 x M8 x 20mm Allen Bolts (46), 3 x M8 Spring Washers (26) and 3 x M8 Curved Washers (27) as shown below. Fit 2 x M8 x 60mm Allen Bolts (45), 2 x M8 Curved Washers (27) and 2 x M8 Locknuts (37) through the lower holes on the Upright as shown below.

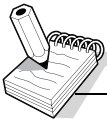

### Note

Do NOT tighten the Handlebar Upright at this stage.  
The Tension Control Knob (74) must be set at position "1".

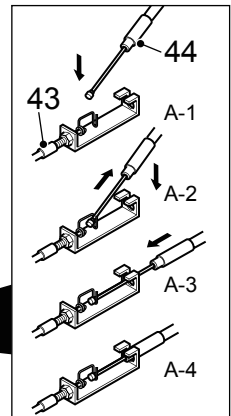
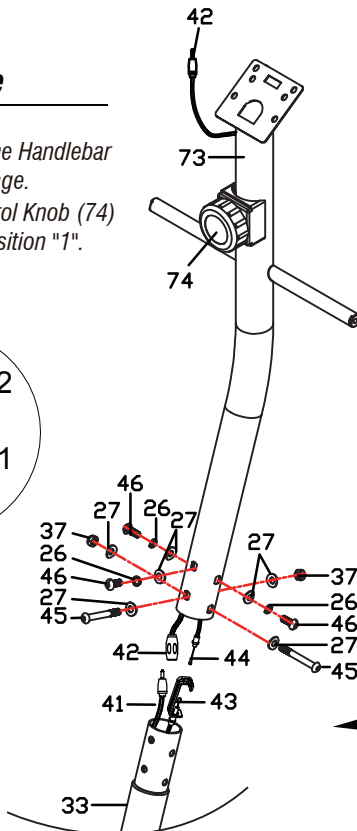
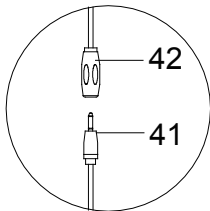

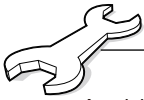

# Assembly

- 3** Attach both Footplates (55) to the Footplate Support Bars (59) using 2 x M10 x 45mm Hex Bolts (56), 2 x M10 Flat Washers (58) and 2 x M10 Nylon Locknuts (57) for each Footplate.  
Note : The Footplates can be fitted in two positions.



## Note

Ensure that the Shouldered Bolts are fully tight before finally securing the Nylon Locknuts. One Bolt is supplied with a RIGHT HAND THREAD for the RIGHT HAND SIDE and must be fitted by turning CLOCKWISE. The other Bolt is supplied with a LEFT HAND THREAD for the LEFT HAND SIDE and must be fitted by turning ANTI-CLOCKWISE.

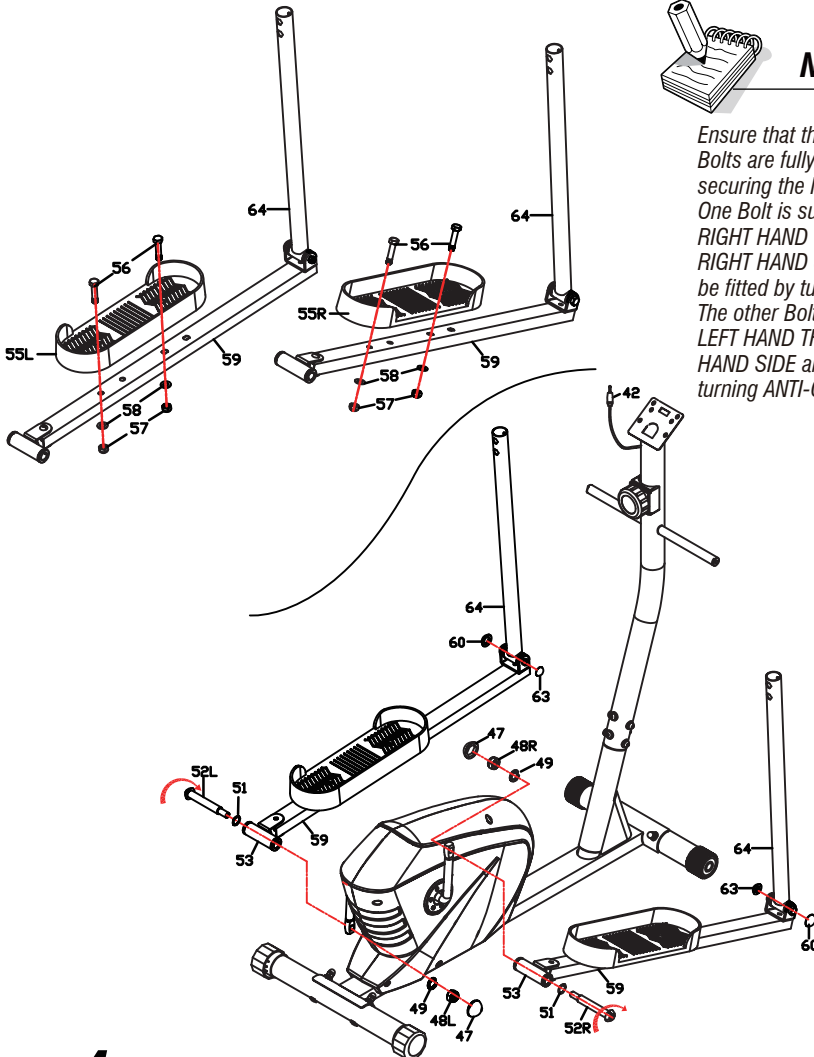

- 4**
- Connect the Footplate Bars (59 L/R) to the Crank arms using 1 x Shouldered Bolt (52L/52R) 1 x Wave Washer (51) through the Footplate Support Bar Pivot Bracket and into the Crank arms, then fit 1 x M13 Spring Washer (49) and 1 x M13 Nylon Locknut (48L/48R) for each side to secure the complete assembly. Cap the M13 Nylon Locknut with 1 x S18 Round Cap (47) for each side. (SEE NOTE)
  - Fit 1 x S17 Round Cap (60) to the outside bolt head and fit 1 x S13 Round Cap (63) to the inside Nylon Locknut as shown for each side.

# Assembly

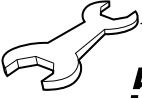

**5**

Fit the Handlebar Bushings (72) and M19 Wave Washers (71) onto each side of Handlebar Upright Pivot Bars first. Now fit the Dual Action Handlebar-Upper (68L/68R) and secure in place using 1 x M8 x 20mm Hex Bolt (14), 1 x M8 Spring Washer (26), 1 x M8 Flat Washer (16) and 1 x D-Flat Washer (66) for each side as shown below. Fit the correct labelled (L or R) Dual Action Handlebar -Upper (68L/68R) into the appropriate Dual Action Handlebar-Lower (64L/64R) and secure in place using 4 x M8 x 40mm Hex Bolts (65), 4 x M8 Curved Washers (27), 4 x M8 Spring Washers (26) and 4 x M8 Dome Nuts (25).

**6**

Attach the Fixed Handlebar (81) to the Handlebar Upright (73) using 2 x M8 x 30mm Allen Bolts (77), 2 x M8 Spring Washers (26) and 2 x M8 Curved Washers (27).

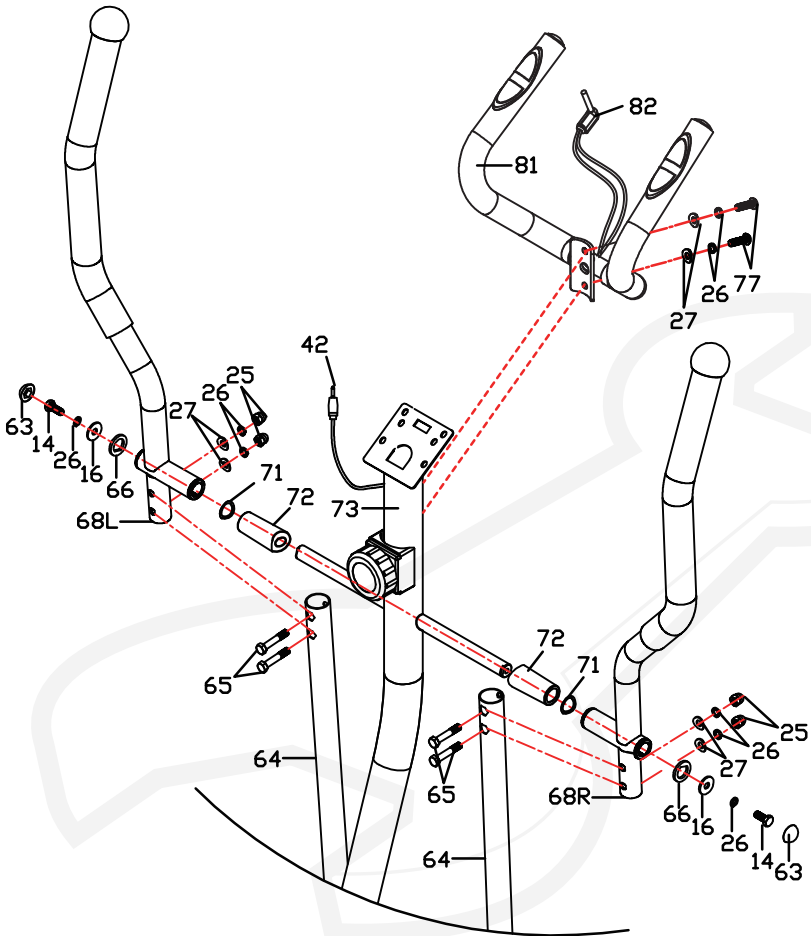

# Assembly

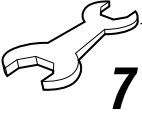

7

Remove the 2 x M5 x 12mm Screws (76) from the back of the Exercise Monitor (83). Connect the Exercise Monitor Link Wire (42) and the Pulse Sensor Wire (82) to the Exercise Monitor (83), matching like for like and feeding any excess wire back into the upright. Carefully fit the Exercise Monitor (83) onto the Exercise Monitor Bracket and secure using 2 x M5 x 12mm Screws (76) that were removed.

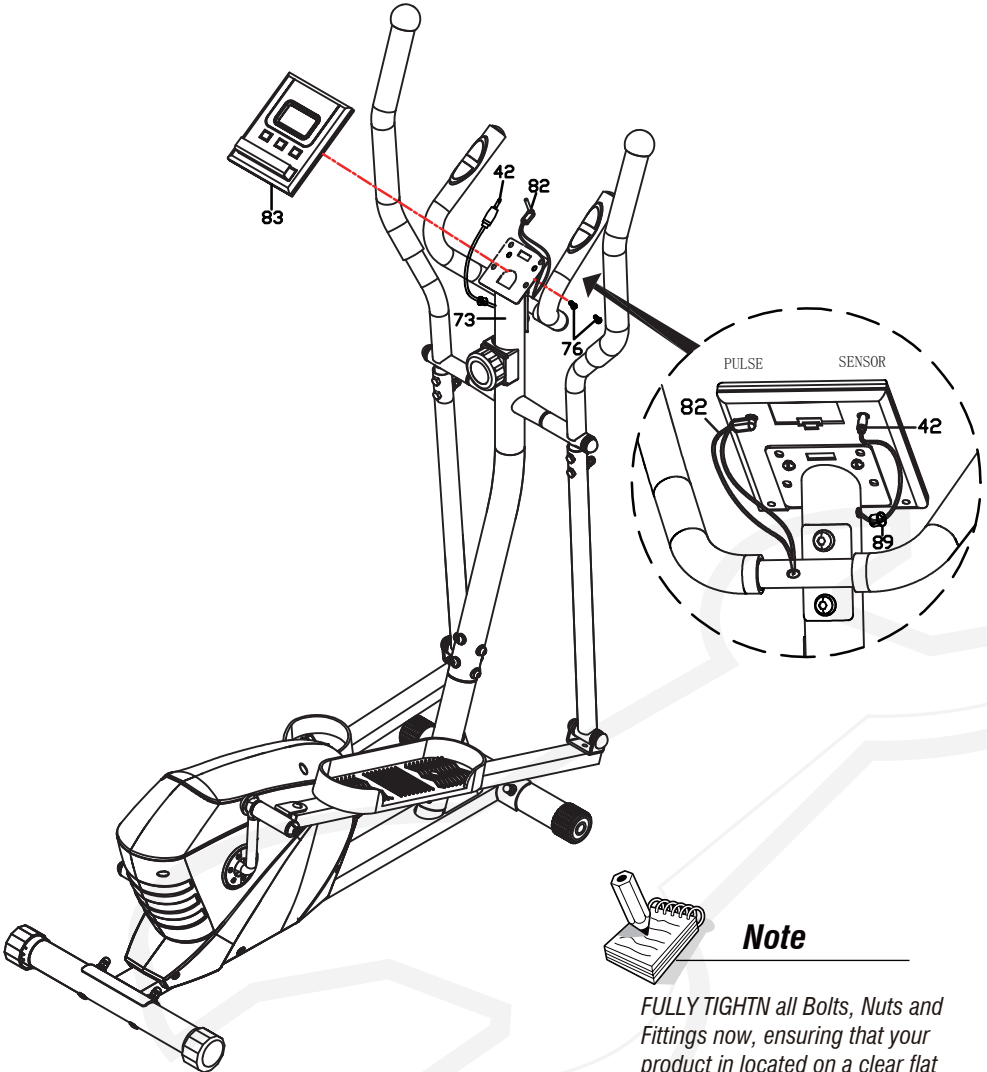

## Note

FULLY TIGHTN all Bolts, Nuts and Fittings now, ensuring that your product is located on a clear flat surface before doing so. Your product will now be ready to use.

# Assembly

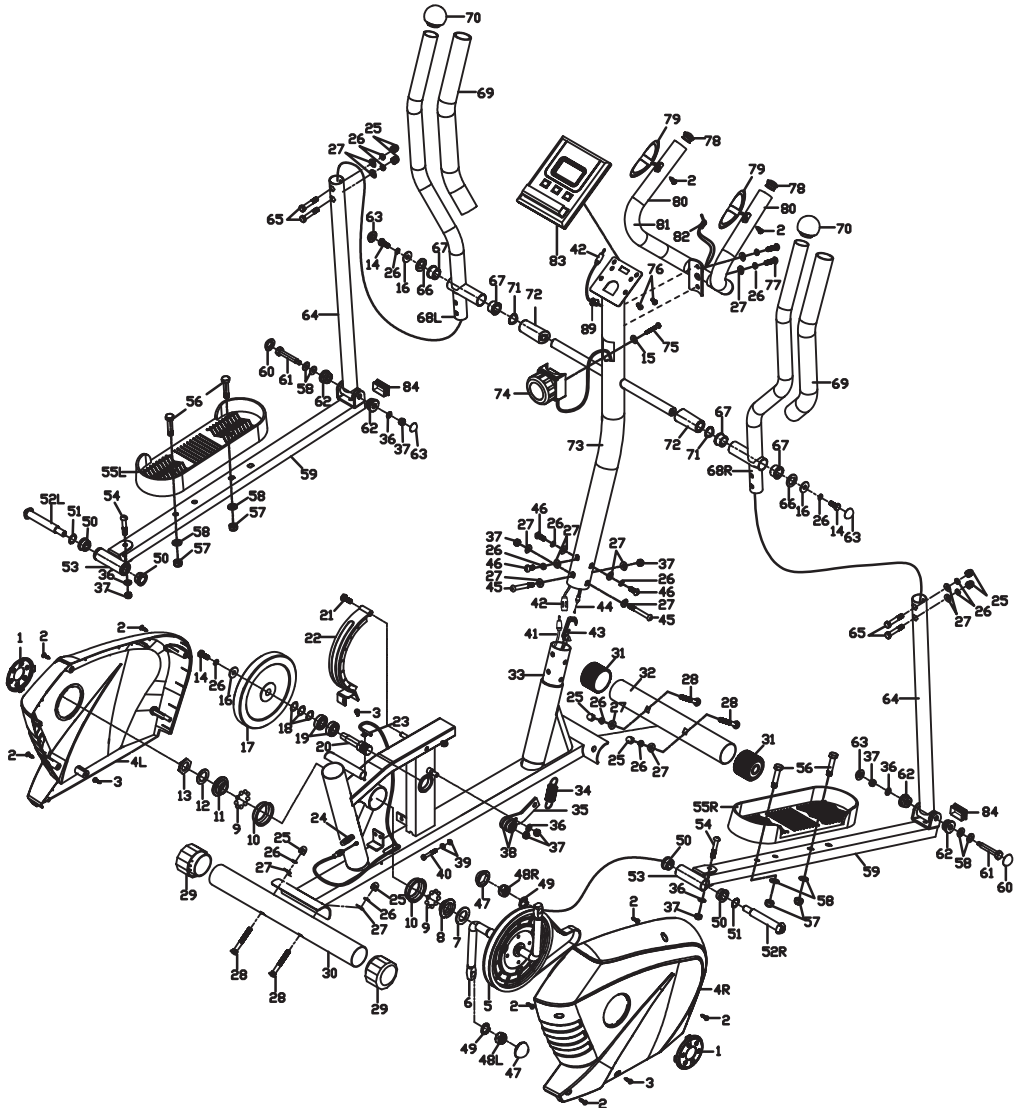

# Assembly

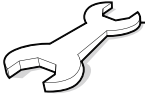

## MASTER PARTS & ACCESSORY LIST

PART No.	DESCRIPTION	QTY
1	Crank Cover Round Cap	2
2	M4 x 20mm Self Tapping Screw	9
3	M4 x 20mm Screw	3
4	Chain Cover (L/R)	2
5	Belt Plate	1
6	Crank	1
7	M24 x 40 Flat Washer	1
8	Shaped Nuts-1	1
9	Ball Bearing	2
10	Nylon Outer Bearing	2
11	Shaped Nuts-2	1
12	M35 x M23 Flat Washer	1
13	Nylon Nut	1
14	M8 x 20mm Hex Bolt	3
15	M6.5 x M14 Curved Washer	1
16	M8 Flat Washer	3
17	Flywheel	1
18	M15 Wave Washer	3
19	Bearing	2
20	M15 Axis	1
21	M5 x 12mm Screw	1
22	Magnet Bracket	1
23	Sensor Base	1
24	M8.5 x M10.5 x 50 Spring	1
25	M8 Dome Nut	8
26	M8 Spring Washer	16
27	M8 Curved Washer	17
28	M8 x 65mm Carriage Bolt	4
29	Rear Hex End Cap	2
30	Rear Stabiliser	1
31	Front Roller End Cap	2
32	Front Stabiliser	1
33	Main Frame	1
34	M18 x M14 x 50 Spring	1
35	Bracket	1
36	M8 Flat Washer	5
37	M8 Nylon Nut	6
38	Wheel Bracket	2
39	M6 Nut	2
40	M6 x 50mm Hex Bolt	1
41	Monitor Link Wire-Lower	1
42	Monitor Link Wire-Upper	1
43	Tension Control Cable-Lower	1
44	Tension Control Cable-Upper	1
45	M8 x 60mm Allen Bolt	2
46	M8 x 20mm Allen Bolt	3
47	S19 Cap	2
48	1/2" Nylon Nut	2
49	M13.5 x M22 Spring Washer	2
50	M28 x M16 Axle Bushing	4
51	M16 Wave Washer	2
52	Pedal Shouldered Bolt L/R	2
53	Connecting Joint	2
54	M8 x 45mm Allen Bolt	2
55	Pedal L/R	1
56	M10 x 45mm Hex Bolt	4
57	M10 Nylon Nut	4
58	M10 Flat Washer	8
59	Footplate Support Bar L/R	2
60	S17 Cap	2
61	Bracket Screw	2
62	Axle Bushing	4
63	S13 Cap	4
64	Dual Action Handlebar L/R	2
65	M8 x 40mm Hex Bolt	4
66	D-Flat Washer	2
67	Axle Bushing	4
68	Dual Action Handlebar L/R	2
69	Dual Action Handlebar Foam	2
70	M32 End Cap	2
71	M19 Wave Washer	2
72	Bushing	2
73	Handlebar Upright	1
74	Tension Control Knob	1
75	M5 x 45mm Screw	1
76	M5 x 12mm Screw	2
77	M8 x 30mm Allen Bolt	2
78	Round End Cap	2
79	Handle Pulse	2
80	Fixed Handlebar Foam	2
81	Fixed Handlebar	1
82	Pulse Sensor Wire	2
83	Exercise Monitor	1
84	Square End Cap	4
85	M13-17-19 Spanner	1
86	M5 Screw Driver	1
87	M8 Screw Driver	1
88	M13-14-15 Spanner	1
89	Grommet	1

# V-fit



## **Beny Sports Co. UK Ltd.**

*Unit 8, Riparian Way,  
The Crossings, Cross Hills,  
West Yorkshire  
BD20 7BW*

## **CUSTOMER SUPPORT**

*is open from 9.00am to 5.00pm from Monday to Friday*



*Tel: 01535 637711*



*Fax: 01535 637722*



*E-mail: [support@benysports.co.uk](mailto:support@benysports.co.uk)*



*Website: [www.benysports.co.uk](http://www.benysports.co.uk)*